BLUE SEAL

E32 CONVECTION OVEN

SERVICE MANUAL



 **turbofan**



 **WARNING: ALL INSTALLATION AND SERVICE REPAIR WORK MUST BE CARRIED OUT BY QUALIFIED PERSONS ONLY.**



CONTENTS

This manual is designed to take a more in depth look at the E32 convection oven for the purpose of making the unit more understandable to service people.

There are settings explained in this manual that should never require to be adjusted, but for completeness and those special cases where these settings are required to change, this manual gives a full explanation as to how, and what effects will result.

SECTION	PAGE NO.
1. SPECIFICATIONS	5
2. INSTALLATION	7
3. OPERATION.....	10
3.1 Description of Controls	
3.2 Explanation of Control System	
4. MAINTENANCE	13
4.1 Cleaning	
4.2 Routine Procedures	
5. TROUBLE SHOOTING GUIDE.....	15
6. SERVICE PROCEDURES.....	18
6.1 Fault Diagnosis	
6.2 Access	
6.3 Replacement	
6.4 Adjustment / Calibration	
7. ELECTRICAL SCHEMATICS	34
8. ELECTRICAL WIRING DIAGRAMS	35
9. SPARE PARTS	36
10. ACCESSORIES / OPTIONS	37
11. PARTS DIAGRAM	38
11.1 Main Assembly	
11.2 Control Panel Assembly	
12. SERVICE CONTACTS	42

 **IMPORTANT:** MAKING ALTERATIONS MAY VOID WARRANTIES AND APPROVALS.

1. SPECIFICATIONS

MODEL: E32

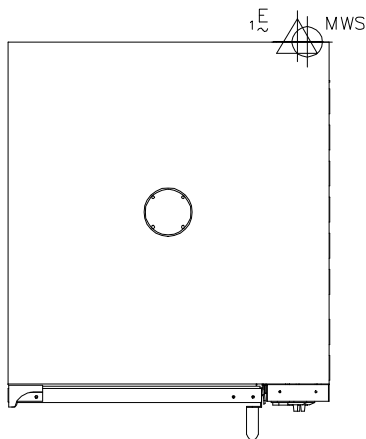
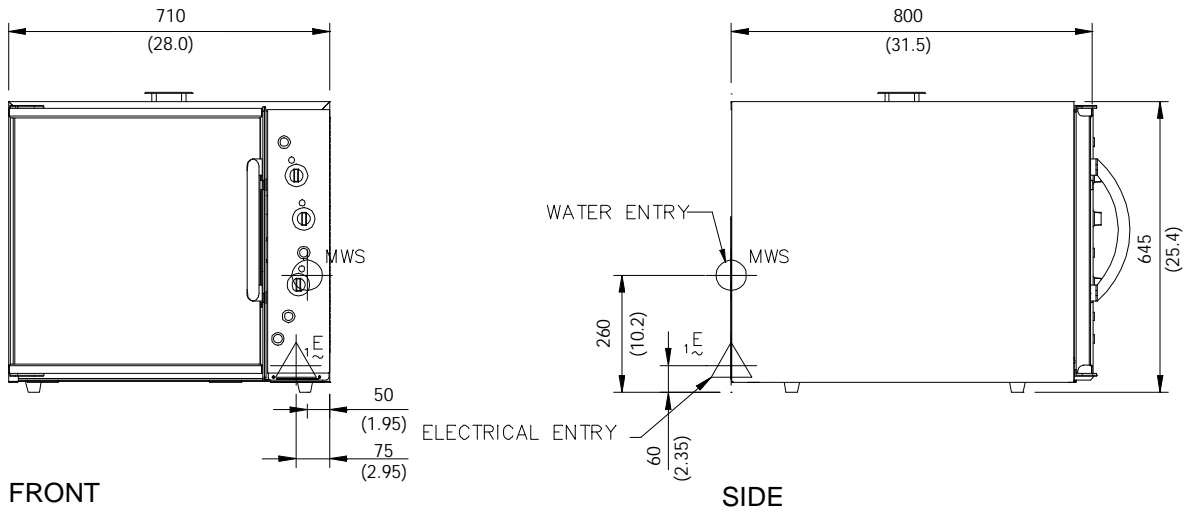

PLAN

LEGEND



- Electrical connection entry point



- Water entry - 3/4" BSP hose connection

Dimensions shown in millimetres.
Dimensions in inches shown in brackets.

LOCATION

To ensure correct ventilation for the motor and controls the following minimum installation clearances are to be adhered to:

Rear	40mm / 1.5"
Left-hand side	40mm / 1.5"
Right-hand side	40mm / 1.5"

OVEN INTERNAL DIMENSIONS

Width	468 mm / 18.5"
Height	533 mm / 21"
Depth	711 mm / 28"
Oven Volume	0.18 m ³ / 6.3 ft ³

OVEN RACK SIZE

Width:	460 mm / 18"
Depth:	660 mm / 26"

No of rack positions: 4

Rack position spacing: 125 mm / 5"

ELECTRICAL SUPPLY SPECIFICATION OPTIONS

208 V AC 60 Hz, 28.8 A , 6.0 kW @ 208 V
220-240 V AC 60 Hz, 27.8 A, 6.7 kW @ 240 V
208-220 V AC 50 Hz, 28.8 A, 6.0 kW @ 208 V
230-240 V AC 50 Hz, 27.8 A, 6.7 kW @ 240 V

ELECTRICAL CONNECTION WIRE CONDUCTOR SIZES

Minimum: 4mm² / 16 AWG

WATER SUPPLY CONNECTION

Max Pressure 550 kPa / 5.5 bar / 80 psi
Min Pressure 100 kPa / 1.0 bar / 15 psi

2. INSTALLATION



WARNING: THIS APPLIANCE MUST BE GROUNDED.



WARNING: ALL INSTALLATION AND SERVICE REPAIR WORK MUST BE CARRIED OUT BY QUALIFIED PERSONS ONLY.

It is most important that the oven is installed correctly and that the operation is correct before use. Installation shall comply with local electrical, health and safety requirements.

BEFORE CONNECTION TO POWER SUPPLY

Unpack and check unit for damage and report any damage to the carrier and dealer. Report any deficiencies to your dealer. Fit the feet which are packed inside the oven. Fit door handle to oven door. Check that the available power supply is correct to that shown on the rating plate located on the right-hand side panel.

208 V AC 60 Hz, 28.8 A , 6.0 kW @ 208 V
220-240 V AC 60 Hz, 27.8 A, 6.7 kW @ 240 V
208-220 V AC 50 Hz, 28.8 A, 6.0 kW @ 208 V
230-240 V AC 50 Hz, 27.8 A, 6.7 kW @ 240 V

LOCATION

To ensure correct ventilation for the motor and controls the following minimum installation clearances are to be adhered to:

Rear	40mm / 1.5"
Left-hand side	40mm / 1.5"
Right-hand side	40mm / 1.5"

Position the oven in its allocated working position. Use a spirit level to ensure the oven is level from side to side and front to back. (If this is not carried out, uneven cooking could occur). The feet/legs used with bench or floor mounting or provided with stands are adjustable and will require adjusting in levelling the unit. It should be positioned so the operating panel and oven shelves are easily reachable for loading and unloading.



IMPORTANT: THE OVEN VENT LOCATED ON THE CABINET TOP MUST NEVER BE OBSTRUCTED.

BEFORE USE

Operate the oven for about 1 hour at 200°C (400°F) to remove any fumes or odours which may be present.

ELECTRICAL CONNECTION

Remove rear cover panel to allow access to the terminal block and strain relief cable clamp. The cable can be fitted through the small grommet and held by the cable clamp. Connect cable to the terminals as marked. Refit cover panel.

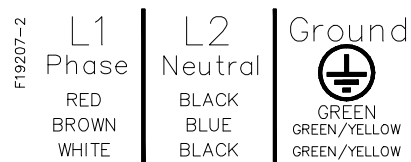

WARNING: THIS APPLIANCE MUST BE GROUNDED / EARTHED

Figure 2.1

Refer to specifications section for minimum wire connections required.

WATER CONNECTION

A cold water supply should be fitted to the water inlet (3/4" BSP hose connection) which is located on the rear of the right hand side of the unit.

Alternately, a connection elbow and sealing washer is supplied with this unit for direct connection of a 1/2" ID hose, and is recommended for easy installation and service.

Connect water supply - Max inlet pressure 80psi / 550kPa.

Turn on water supply to check for leaks.



IMPORTANT: MAXIMUM INLET WATER PRESSURE IS 550 kPa / 80 psi.

DOOR HANDLE INSTALLATION

1. Open oven door.
2. Remove two screws (item 2).
3. Remove the two screws (item 3) from the handle (item 1).
4. Install the handle bracket through the slot on the door side.
5. Screw in the two screws (item 2) fully, then fully screw in the previous two screws (item 3). Ensure that they are tight.

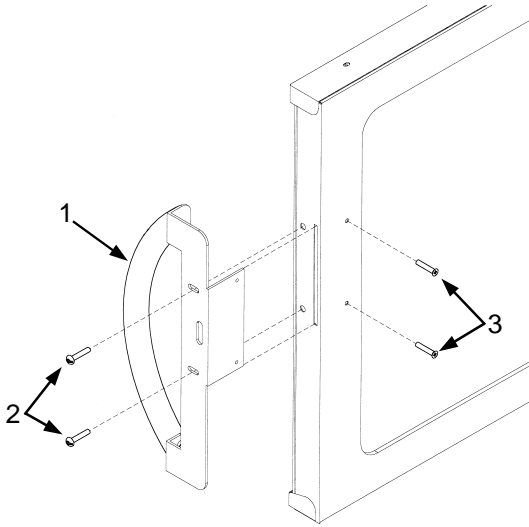

Figure 2.2

OVEN RACKS

The oven is supplied with four general purpose oven racks. These racks incorporate two important safety features:

1. **Self Supporting:** When fitted, the oven racks are self supporting and will not drop or angle down when the racks are withdrawn during operation, when loading and unloading products on racks or when attending to the product being cooked during its cook cycle.
2. **Auto Supporting:** The oven rack supports incorporate a special retaining tab which provides a positive stop to each oven rack and stops its inadvertent removal during normal operation.

To fit the oven racks ensure that the rack back stop is positioned at the rear of the oven and install by following the steps shown in the diagram below.

To remove oven racks reverse the procedure.

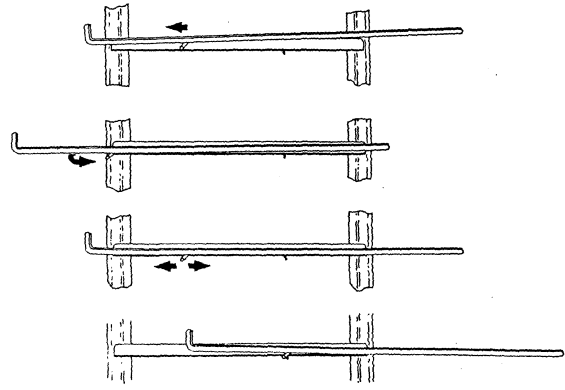

Figure 2.3

DOUBLE STACKING UNITS

When it is desired to mount an E32 Turbofan oven on an E87 prover, a double stacking kit must be used. Available from your dealer or Turbofan distributor. (see Spare Parts).

When mounting one oven on top of another, a double stacking kit is also required.

!

WARNING: THE ELECTRICAL SUPPLY MUST BE DISCONNECTED BEFORE UNITS ARE STACKED.

Assembly Steps:

Bottom Unit

1. Lay unit on back and remove 1" or 4" feet already fitted to unit. Fit adjustable leg and secure with (16x) M6 x 16 taptite screws. Stand unit up.
2. Unscrew vent hood plate from bottom oven. Remove and discard hood plate and spacer tubes. Replace two vent hood screws on the left hand side from the front and screw in completely to secure outer wrapper to vent tube. Use RTV to seal the other two holes.
3. Position shroud back on top of bottom unit so that it is positioned correctly over oven back. Position flue duct on bottom unit so that it is positioned centrally in shroud back flue cut-out and is flush with the oven back. Check that the oven vent is covered and mark the six hole positions (3 down each side of the flue duct) on the oven wrapper.
4. Drill six \varnothing 3.5mm holes in the oven wrapper where marked.
5. Screw the flue duct to the wrapper with six 1/2" x 8A pozi screws into these holes.

Top Unit

1. Tip oven onto its back and remove the 1" or 4" feet screwed into the base.
2. Assemble the four sides of the shroud (shroud front, shroud back, shroud sides (x2)) with the 3/16" screws as shown. Do not tighten the screws until the ovens are stacked.
3. Screw the shroud assembly to the base of the oven using the 3/8" screws and washers so that all faces of the shroud are flush with the sides of the oven base. Be sure to have the large flange of the shroud back at the rear of the oven.

Stacking the Ovens

1. Remove the outside two screws along the top rear of the bottom oven.
2. With two or three persons, lift the top oven onto the bottom oven and position so that the down folds on the shroud sides and back all butt hard up around the back and sides of the oven wrapper.
3. Secure top unit into position by replacing the two outside screws of the four previously removed from the top rear of the bottom unit.



Figure 2.4

4. Screw together with four 1/2" x 8A pozi screws supplied, the chimney to the flue duct of the bottom unit. Drill two Ø3.5mm holes in the top rear of the top unit through the two round holes, one each side of the chimney. Now screw the chimney to the rear of the top unit with the two remaining 1/2" x 8A pozi screws.
5. Adjust the four legs to level ovens.

RATING PLATE LOCATION

The rating plate for the E32 convection oven is located at the bottom right corner of the RH side panel.

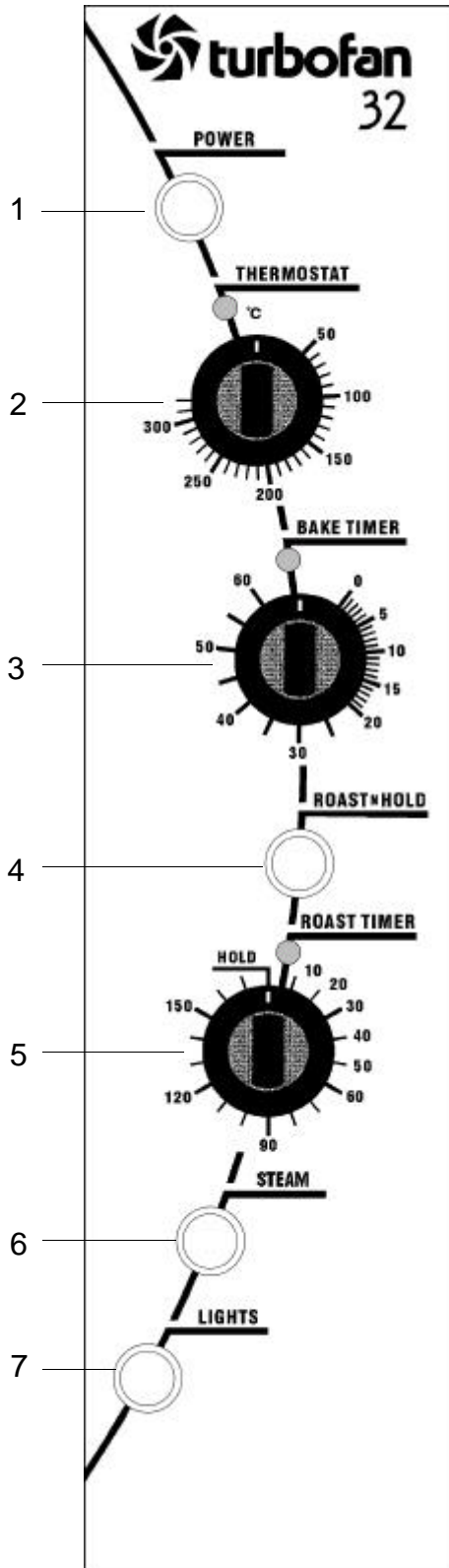

Figure 2.5

3. OPERATION

NOTE: A full user's operation manual is supplied with the product and can be used for further referencing of installation, operation and service.

3.1 DESCRIPTION OF CONTROLS



1. POWER

Depress to switch power on or off (switch illuminates when power is on).

2. THERMOSTAT

Temperature range 50 - 320°C (120 - 600°F). Light illuminates when elements are cycling ON to maintain set temperature.

3. BAKE TIMER

1 Hour bake timer. (Light illuminates when "time up" (0) reached, and buzzer sounds).

4. ROAST N HOLD

Depress switch to activate 'ROAST N HOLD' function (Switch illuminates when ON).

5. ROAST TIMER

3 Hour roast timer. (Light illuminates when "time up" (0) reached, and product held at 75°C (167°F)).

6. STEAM SWITCH

Push switch to activate water injection (Water injects into oven while the button is depressed).

7. LIGHT SWITCH

Push switch to activate light. (Light illuminates while button depressed).

3.2 EXPLANATION OF CONTROL SYSTEM

The E32 Turbofan convection oven features multi-function operator controls for which a correct understanding of their operation is required before carrying out any service or fault repair work. The control device functions are explained as follows:

A power switch on the control panel isolates all to the controls of the oven. With the power switch Off all functions of the oven are inoperable.

With the power switch On (illuminated) power is directly supplied to the 60 minute bake timer, steam (water injection) switch, door microswitch, light switch, and the temperature control circuit. The oven circulation fan will operate only when the thermostat is turned on. The control panel light switch will turn the oven lights on when the door is closed only when the light switch is held in. The oven lights will come on automatically when the door is open, as this is controlled by the door microswitch.

The 60 minute timer is a mechanical timer and can therefore be operated with the oven's power switch On or Off. However, only with the oven's power switch On will the switch contacts of the 60 minute timer turn on the time-up buzzer and illuminate the time-up indicator on the control panel. The buzzer and time-up indicator provide indication that the time setting has run down to zero and at this point will remain On continuously until the 60 minute timer has been manually set back to the Off (vertical) position. The 60 minute timer does not control any other part of the oven's operating system as this timer is independent of the temperature control and heating system.

The steam (water injection) switch on the control panel can be operated whenever the power switch is On. The switch is momentary like the light switch and when depressed, will operate the electric solenoid valve at the rear of the oven and inject water across the elements and fan from the flat spray (vertical) nozzle positioned at the rear of the oven elements. Releasing the steam button will close the solenoid valve. This feature is used to instantaneously add steam into the oven.

The temperature control of this oven is with a

capillary type thermostat which can be set to a required cooking temperature.

The thermostat switch has a separate switch body assembled onto the front from the shaft assembly and when the thermostat is set to a cooking temperature, the switch contacts turn on the oven fan. The switch is closed (fan on) whenever the thermostat is not in the Off (vertical) position. The control panel indicator light above the thermostat knob cycles On and Off with the thermostat to indicate when the elements are on and the oven is heating.

The E32 Turbofan convection oven has 6.5 kW of electric heating elements, comprising of a 3 kW inner coil, and a 3.5 kW outer coil, both of which make up the element assembly around the oven fan. The elements are switched on and off by the main oven thermostat or hold thermostat via a four-pole 25 Amp contactor located inside the control housing. Only two poles of the contactor are used, one for each element coil.

The E32 Turbofan convection oven features a Roast-and-Hold system which can be used to automatically set the oven to a fixed holding temperature at the end of a timed cooking period. When the Roast-and-Hold switch is turned On the switch will illuminate and switch on a relay found inside the control panel, at the base of the control housing next to the door microswitch. When the relay is switched ON a normally closed switch pole on the relay is opened and the normal power supply to the oven thermostat is isolated. A second normally open switch pole is closed and this provides power to the 3 hour roast timer.

If the roast timer is in the Hold (vertical) position the timer switch contacts will be in their normally closed position and supply power directly to the Hold thermostat located behind the control panel. The Hold thermostat is factory set to 75°C (167°F) and will supply power to the heating elements through the heating contactor as required to maintain its preset temperature.

The thermostat heating light will also cycle On/Off as the Hold thermostat maintains temperature.

In the Roast-and Hold mode the 3 hour timer can be set to a selected roasting time. During this time period the normally open switch contacts of the timer are closed. The timer has two change over switches and in this

position one is used to supply power to its timing motor and the other is used to switch power directly to the main oven thermostat. During the 3 hour timer run-down period the oven temperature will be controlled by the main oven thermostat to the set temperature and operate as previously described.

When the 3 hour timer has run down and reached the Hold position the two switch contacts change over to their normally closed position which isolates power from the timer motor and the oven thermostat. It also switches power back to the oven hold thermostat. At this point the temperature control is now maintained by the hold thermostat as previously described. To cancel the hold circuit the Roast-and-Hold switch is turned Off. This turns off the contactor which removes power from the 3 hour timer and closes the contactor pole on the contactor that feeds the main oven thermostat. The Hold indicator light above the 3 Hour timer will illuminate whenever the oven is operating in hold mode (Roast 'n Hold selected, and 3 Hour timer at zero position).

The factory preset hold thermostat can be adjusted as required to change the holding temperature if necessary. Refer Service section for this procedure.

The following Troubleshooting Guide should be used to identify any incorrect oven operation. On correct identification of the operating fault the Troubleshooting Guide will make reference to the corrective action required, or refer to the Fault Diagnosis section and/or Service section to assist in correction of the fault.

4. MAINTENANCE

 **WARNING:** ALL INSTALLATION AND SERVICE REPAIR WORK MUST BE CARRIED OUT BY QUALIFIED PERSONS ONLY.

4.1 CLEANING

 **WARNING:** ALWAYS TURN THE POWER SUPPLY OFF BEFORE CLEANING.

 **IMPORTANT:** THIS UNIT IS NOT WATER PROOF. DO NOT USE A WATER JET SPRAY TO CLEAN INTERIOR OR EXTERIOR OF THIS UNIT.

washed in the sink, but take care not to cut or damage them. To replace, ensure that the lip is facing the oven opening. Fit the top and bottom seals first, then the side seals.

OVEN DOOR GLASS

Clean with conventional glass cleaners.

EXTERIOR

Clean with a good quality stainless steel cleaning compound. Harsh abrasive cleaners may damage the surface.

INTERIOR

Ensure that the oven chamber is cool. Do not use wire brushes, steel wool or other abrasive materials. Clean the oven regularly with a good quality oven cleaner. Take care not to damage the fan or the tube at the right side of the oven which controls the thermostat.

OVEN RACKS

To remove, slide out to the stop position, raise the front edge up, and lift out.

SIDE RACKS

To remove, lift front top to disengage and slide rack forward. To replace, slide top rear slot in rack onto rear stud, then engage front keyhole on front stud.

LAMP GLASS

To remove glasses, unscrew anti-clockwise. To replace, screw in clockwise.

 **IMPORTANT:** DO NOT OVERTIGHTEN LAMP GLASS.

OVEN SEALS

To remove, hold at their centre point and pull forward until they unclip. Remove side seals first, then top and bottom. The seals may be

4.2 ROUTINE PROCEDURES

	PROCEDURE	INTERVAL
DOOR SEALS	Check for deterioration.	12 months
DOOR PIVOT BUSHES	Check for wear.	12 months
DOOR CATCH	Ensure that catch is adjusted such that the door closes properly.	12 months
ELEMENT	Check that element resistance is correct to it's rating (refer 6.3.15).	12 months
WATER NOZZLE	Check for liming in water nozzle.	12 months

5. TROUBLE SHOOTING



WARNING: ALL INSTALLATION AND SERVICE REPAIR WORK MUST BE CARRIED OUT BY QUALIFIED PERSONS ONLY.

FAULT	POSSIBLE CAUSE	REMEDY
THE OVEN DOES NOT OPERATE / START	The mains isolating switch on the wall, circuit breaker or fuses are "off" at the power board.	Turn on.
	The power switch on the oven is off.	Depress switch. Switch will illuminate.
	Incorrect electrical supply. (Refer fault diagnosis 6.1.1)	Ensure electrical supply correct.
	Power switch on unit faulty. (Refer fault diagnosis 6.1.1)	Replace. (Refer service section 6.3.4)
FAN DOESN'T OPERATE	Thermostat not on. <i>(Fan only operates when the thermostat is on).</i>	Turn thermostat on.
	Thermostat fan switch faulty. (Refer fault diagnosis 6.1.2)	Replace thermostat. (Refer service section 6.3.9)
	Fan motor faulty. (Refer fault diagnosis 6.1.2)	Replace. (Refer service section 6.3.17)
	Wiring.	Check and tighten any loose wiring.
OVEN LIGHT NOT ILLUMINATING - DOOR OPEN (AUTOMATICALLY ON)	Blown bulb.	Replace. (Refer service section 6.3.1)
	No power to light. (Refer fault diagnosis 6.1.3)	Correct fault.
OVEN LIGHT NOT ILLUMINATING - DOOR CLOSED (MANUALLY SWITCHED ON)	Blown bulb.	Replace. (Refer service section 6.3.1)
	Light switch faulty. (Refer fault diagnosis 6.1.4)	Replace. (Refer service section 6.3.4)
NO WATER INJECTION / STEAM	Water not turned on.	Turn water on at water supply.
	Oven water nozzle blocked.	Remove, clean or replace. (Refer service section 6.3.14)
	Fault with water valve. (Refer fault diagnosis 6.1.5)	Service or replace as required. (Refer service section 6.3.12, 6.3.13)
	Steam switch faulty.	Replace. (Refer service section 6.3.4)

FAULT	POSSIBLE CAUSE	REMEDY
CONTINUOUS WATER OUT OF OVEN WATER NOZZLE	<p>With oven on only—Electrical fault. (Refer fault diagnosis 6.1.6)</p> <p>With oven on or off—Fault with water valve. (Refer fault diagnosis 6.1.5)</p>	<p>Correct electrical fault.</p> <p>Service or replace as required. (Refer service section 6.3.12, 6.3.13)</p>
<p>60 MINUTE TIMER WILL NOT TIME DOWN</p> <p>60 MINUTE TIMER INACCURATE BELOW 20 MINUTES</p> <p>60 MINUTE TIMER NO TIME UP BUZZER</p> <p>60 MINUTE TIMER NO TIME UP INDICATOR</p>	<p>Timer faulty.</p> <p>Timer not set correctly.</p> <p>Zero (time up) position not set correctly.</p> <p>Buzzer faulty. (Refer fault diagnosis 6.1.7)</p> <p>Timer not switching on buzzer. (Refer fault diagnosis 6.1.7)</p> <p>Indicator faulty. (Refer fault diagnosis 6.1.8)</p>	<p>Replace. (Refer service section 6.3.7)</p> <p>For timer settings below 20 minutes, always rotate past 20 minutes, then back to desired time.</p> <p>(Refer service section 6.4.6)</p> <p>Replace. (Refer service section 6.3.5)</p> <p>Replace. (Refer service section 6.3.7)</p> <p>Replace. (Refer service section 6.3.3)</p>
NO HEAT	<p>No power to thermostat. (Refer fault diagnosis 6.1.9)</p> <p>Thermostat faulty. (Refer fault diagnosis 6.1.9)</p> <p>Heating contactor faulty. (Refer fault diagnosis 6.1.9)</p> <p>Element faulty (blown). (Refer fault diagnosis 6.1.9)</p>	<p>Identify fault and correct.</p> <p>Replace. (Refer service section 6.3.9)</p> <p>Replace. (Refer service section 6.3.11)</p> <p>Replace. (Refer service section 6.3.15)</p>
NO TEMPERATURE CONTROL (TEMPERATURE OVERRUN)	<p>Heating contactor faulty. (Refer fault diagnosis 6.1.9)</p> <p>Thermostat faulty. (Refer fault diagnosis 6.1.10)</p>	<p>Replace. (Refer service section 6.3.11)</p> <p>Replace. (Refer service section 6.3.9)</p>
SLOW RECOVERY	<p>Oven in 'Roast 'n Hold' mode.</p> <p>Overloading of oven.</p> <p>Electrical supply incorrect.</p> <p>Fan not working.</p> <p>Thermostat out of calibration. (Refer fault diagnosis 6.1.11)</p> <p>Element not working.</p>	<p>Switch off 'Roast 'n Hold'.</p> <p>Reduce oven loading.</p> <p>Check supply voltage is as per rating plate voltage.</p> <p>Check fan operation.</p> <p>Correct calibration. (Refer service section 6.4.1)</p> <p>Correct element fault. (Refer Fault: No Heat)</p>

FAULT	POSSIBLE CAUSE	REMEDY
ELEMENT NOT WORKING	Element faulty (blown). (Refer fault diagnosis 6.1.9)	Replace. (Refer service section 6.3.15)
NO THERMOSTAT HEATING INDICATOR	Indicator faulty. (Refer fault diagnosis 6.1.12)	Replace. (Refer service section 6.3.3)
ROAST TIMER (180 MINUTE) WILL NOT TIME DOWN	Roast 'n' Hold switch not depressed.	Depress switch. Switch will illuminate.
NO HOLD INDICATOR	No power to timer / timer faulty.. (Refer fault diagnosis 6.1.13)	Correct electrical fault / replace timer. (Refer service section 6.3.8)
NO HOLD INDICATOR	'Roast 'n Hold' switch faulty. (Refer fault diagnosis 6.1.13)	Replace. (Refer service section 6.3.4)
NO HOLD INDICATOR	Faulty indicator. (Refer fault diagnosis 6.1.14)	Replace. (Refer service section 6.3.3)
NO HOLD INDICATOR	Faulty timer. (Refer fault diagnosis 6.1.14)	Replace. (Refer service section 6.3.8)
HOLDING TEMPERATURE INCORRECT	Hold thermostat set temperature incorrect.	Adjust to correct temperature. (Refer service section 6.4.5)
HOLDING TEMPERATURE INCORRECT	Hold thermostat faulty. (Refer fault diagnosis 6.1.15)	Replace. (Refer service section 6.3.10)
DOOR DOES NOT CLOSE	Tray in way of door.	Correctly position tray in rack.
DOOR DOES NOT CLOSE	Door seal obstruction.	Correctly install door seal. (Refer service section 6.3.20)
DOOR DOES NOT CLOSE	Door handle installed incorrectly.	Fit correctly. (Refer installation section)
DOOR DOES NOT CLOSE	Door catch setting incorrect.	Adjust. (Refer service section 6.4.3)
DOOR DOES NOT CLOSE	Door pivot bushes / pins worn.	Replace. (Refer service section 6.3.21)
DOOR SEAL LEAKS	Door seal damaged.	Replace. (Refer service section 6.3.20)
DOOR SEAL LEAKS	Door seal incorrectly fitted.	Correctly install door seal. (Refer service section 6.3.20)
DOOR SEAL LEAKS	Door catch setting incorrect.	Adjust. (Refer service section 6.4.3)
DOOR SEAL LEAKS	Door pivot bushes / pins worn.	Replace. (Refer service section 6.3.21)
DOOR SEAL LEAKS	Door catch striker plate worn.	Replace. (Refer installation instructions—Door handle installation)

6. SERVICE PROCEDURES

 **WARNING:** ENSURE POWER SUPPLY IS SWITCHED OFF BEFORE SERVICING.

 **WARNING:** ALL INSTALLATION AND SERVICE REPAIR WORK MUST BE CARRIED OUT BY QUALIFIED PERSONS ONLY.

SECTION	PAGE NO.
6.1 FAULT DIAGNOSIS.....	20
6.1.1 Oven Does Not Operate / Start	20
6.1.2 Fan Does Not Operate	20
6.1.3 Oven Light Not Illuminating—Door Open	20
6.1.4 Oven Light Not Illuminating—Door Closed	20
6.1.5 No Water Injection / Steam	20
6.1.6 Continuous Water Out Of Oven Water Nozzle.....	21
6.1.7 60 Minute Timer No Time Up Buzzer	21
6.1.8 60 Minute Timer No Time Up Indicator	21
6.1.9 No Heat	21
6.1.10 No Temperature Control (Temperature Overrun)	22
6.1.11 Slow Recovery.....	22
6.1.12 No Thermostat Heating Indicator	22
6.1.13 Roast Timer (180 Minute) Will Not Time Down.....	22
6.1.14 No Hold Indicator.....	23
6.1.15 Holding Temperature Incorrect.....	23
6.2 ACCESS.....	24
6.2.1 Control Panel.....	24
6.2.2 Service Panel (Side Panel).....	24
6.2.3 Service Panel (Rear Panels).....	24
6.2.4 Control Panel (Rear).....	24
6.3 REPLACEMENT	25
6.3.1 Light Bulb / Glass	25
6.3.2 Door Microswitch	25
6.3.3 Indicator Neon Light	25
6.3.4 Power / Roast / Lights / Water Switches	25
6.3.5 Buzzer.....	25
6.3.6 Hold Relay	26
6.3.7 Bake Timer	26
6.3.8 Roast Timer	26
6.3.9 Thermostat.....	26
6.3.10 Hold Thermostat	27
6.3.11 Heating Contactor.....	27
6.3.12 Water Solenoid	28
6.3.13 Water Solenoid Cleaning.....	28
6.3.14 Spray Nozzle	28
6.3.15 Elements.....	28
6.3.16 Fan.....	29
6.3.17 Motor.....	29
6.3.18 Outer Glass	29
6.3.19 Inner Glass	30

6.3.20	Door Seals.....	30
6.3.21	Door Pivot Bushes.....	30
6.3.22	Stainless Steel Door—Outer Glass.....	31
6.3.23	Stainless Steel Door—Inner Glass.....	31
6.4	ADJUSTMENT / CALIBRATION.....	32
6.4.1	Thermostat Calibration.....	32
6.4.2	Door Microswitch Adjustment.....	33
6.4.3	Door Catch Adjustment.....	33
6.4.4	Door Alignment.....	33
6.4.5	Hold Temperature Adjustment.....	33
6.4.6	60 Minute Timer Zero Position Adjustment.....	33

6.1 FAULT DIAGNOSIS

6.1.1 OVEN DOES NOT OPERATE / START

Incorrect electrical supply

Check that the voltage across phase and neutral (L1 and L2) terminals of terminal block is the voltage as stated on the unit's electrical rating plate.

If incorrect, check electrical connection of supply wiring and / or check electrical supply.

Power switch faulty

Check if power switch latches. If the switch does not latch, then switch is faulty—replace.

With switch latched, check voltage across terminal one to terminal three or four. If there is no voltage, check for fault in wiring.

Check voltage across terminal two to terminal three or four. If there is no voltage, then switch is faulty—replace.

NOTE: When power switch is latched, it should illuminate if operating correctly.

6.1.2 FAN DOESN'T OPERATE

Fan motor faulty

Check the supply voltage across motor terminals. If there is no voltage then check the electrical connections of supply wiring.

If voltage is correct then check the oven fan for free rotation. Remove any obstruction.

If fan is free to spin and the voltage supply is correct, then the motor is faulty—replace.

Fan switch faulty

Check that the thermostat has power to terminal 5 on switch body on the front of the thermostat when power switch is ON. If no voltage check wiring. Check that terminal P5 has power switched to it when the thermostat is turned on. If no power to terminal P5 switch is faulty and thermostat c/w switch needs to be replaced.

6.1.3 OVEN LIGHTS NOT ILLUMINATING—DOOR OPEN (AUTOMATICALLY ON)

No power to lights

Check the supply voltage across lamp housing terminals at RH side rear of oven. If the voltage is correct, replace the bulb (if faulty). If the bulb is OK, check lamp housing.

Replace if faulty.

If there is no voltage, open oven door and manually depress door microswitch actuator at bottom right of oven. If this activates the lights, then the microswitch actuator arm behind the control panel requires adjustment.

Check voltage across micro-switch terminals to neutral.

With the door open there should be power to the com terminal and the n.c. terminal.

If not, microswitch is faulty—replace.

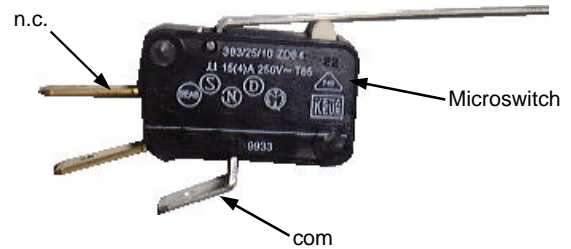

Figure 6.1.1

6.1.4 OVEN LIGHTS NOT ILLUMINATING—DOOR CLOSED (MANUALLY SWITCHED ON)

Light switch faulty

Check voltage to the bottom terminal of the switch. If there is no voltage, then check wiring.

With switch depressed, check voltage at top terminal. If there is no voltage, then replace the switch.

If voltage is correct, then check wiring to light.

NOTE: Alternately, perform a continuity test across the terminals with the light switch depressed.

6.1.5 NO WATER INJECTION / STEAM

Fault with water valve

Check voltage supply across the water valve solenoid coil with the steam switch depressed. If there is no power supply then check the control panel steam switch.

Check voltage to the bottom terminal of the switch. If there is no voltage, then check wiring.

With switch depressed, check for voltage at top terminal. If there is no voltage then replace switch. If voltage correct, check wiring to solenoid coil.

If power supply to the coil is correct, disconnect wiring to coil and check the resistance of the coil windings.

Correct coil resistance: 3650 ohms

NOTE: If open circuit / high resistance, then the coil is faulty—replace.

If coil resistance is correct, rewire and listen for an audible solenoid click when the steam switch is depressed.

If solenoid can be heard functioning, and oven water nozzle is not blocked, then remove water solenoid and fittings and check for blockages.

6.1.6 CONTINUOUS WATER OUT OF OVEN WATER NOZZLE

Water solenoid electrical fault

With control panel steam switch not depressed, check for power supply across solenoid coil. If there is power to the coil, then check wiring and steam switch (refer 6.1.5).

6.1.7 60 MINUTE TIMER NO TIME UP BUZZER

Buzzer faulty

With timer in 'zero' position, check the buzzer at side of control panel (inside) for voltage across terminals. If voltage is correct then buzzer is faulty—replace.

If there is no voltage, then check wiring.

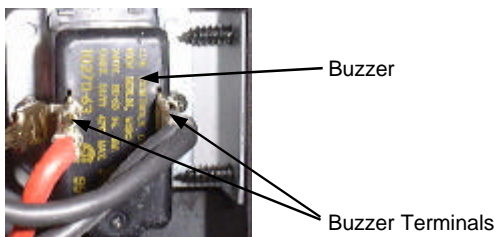

Figure 6.1.2

Timer not switching on buzzer

With timer in zero position, check voltage to top connection (terminal one) and bottom connection (terminal two) of timer. If there is no voltage at terminal one then check wiring.

If no voltage at terminal two then timer is faulty—replace.

NOTE: Timer will continue to run approximately three minutes below zero. Buzzer and time up indicator will continue until the timer is manually switched off (to vertical position).

6.1.8 60 MINUTE TIMER NO TIME UP INDICATOR

Indicator faulty

With the timer in the zero position, check for voltage across the indicator light. If correct, then the indicator light is faulty—replace.

If there is no voltage then check wiring.

6.1.9 NO HEAT

No power to thermostat

Check voltage to terminal 2 on oven thermostat. If there is no voltage then check voltage through terminal 5 and one on hold relay (behind control panel). If there is no voltage to terminal 5 then check wiring. If there is no voltage to terminal 1 then check that the hold relay has no power at relay coil terminal 7. If relay coil is not energised (ie no power at 7) and no power out of terminal 1, then the relay is faulty—replace.

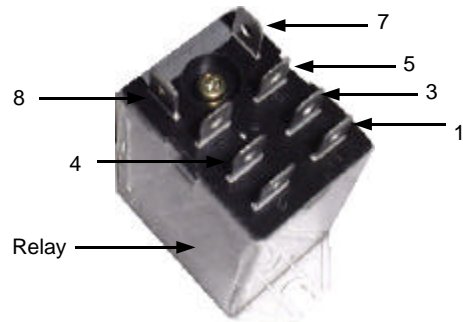

Figure 6.1.3

If relay is energised (ie power at 7) then 'Roast n Hold' switch is on and unit is in hold mode. Turn off 'Roast n Hold' and recheck operation.

NOTE: There should be no voltage across these terminals when 'Roast 'n Hold' is not selected.

Thermostat faulty

Set thermostat to 200°C or 400°F. Check the voltage out of terminal 1 on the thermostat. If there is no voltage then the thermostat is faulty—replace.

If the voltage is correct and the heating light is on then check all wiring to heating contactor.

Heating contactor faulty

With thermostat on, check that the heating contactor coil has power to terminal A1 and voltage across the coil, terminals A1 and A2. If incorrect check wiring.

If voltage is correct, check that contactor pulls in and closes the contacts when power to con-

tactor coil is on. Correct operation will make an audible noise when closing contacts and on the front face of the contactor the contact mechanism will visibly pull in. If not, contactor is faulty—replace.

If contactor operates correctly, check continuity through the poles of the contactor when closed. If no continuity through connected poles then contacts are blown and contactor requires replacing.

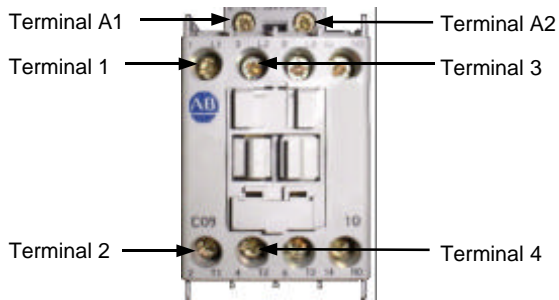

Figure 6.1.4

For checking elements where temperature overrun is occurring, check that contactor releases (opens) when thermostat is switched OFF. If not, contacts of the contactor have welded shut and elements will be ON and heating will be continuous. Contactor is faulty—replace.

Element faulty (blown)

With the thermostat on and heating check voltage across element terminals at RH side of oven. If the voltage is correct then check the current draw of element. If there is no current draw then element is faulty—replace.

If there is no voltage then check voltage is being supplied to each element coil from the heating contactor. If no voltage to elements, check contactor operation (refer 6.1.9) and wiring.

NOTE: Correct element current draw:

208 V :	Inner Coil	12.9A ± 2.5%
	Outer Coil	15.0A ± 2.5%
220 V :	Inner Coil	13.6A ± 2.5%
	Outer Coil	15.9A ± 2.5%
240 V :	Inner Coil	12.5A ± 2.5%
	Outer Coil	14.6A ± 2.5%

6.1.10 NO TEMPERATURE CONTROL (TEMPERATURE OVERRUN)

Heating contactor faulty

Refer 6.1.9

Thermostat faulty

With thermostat in off (vertical) position, the

heating indicator should be off. If not then the thermostat is faulty—replace.

6.1.11 SLOW RECOVERY

Thermostat out of calibration

Place an accurate digital thermometer probe in centre of oven. Set thermostat to 180°C or 355°F. Close the oven door and allow oven thermostat to cycle on and off twice. Record oven centre temperature for the next thermostat on and off cycle. The thermostat should cycle on and off between 165°C and 195°C or 330°F and 385°F when set to the above temperature. If oven temperature is outside these ranges, then the thermostat requires recalibration.

NOTE: Thermostat cycling span should be ±15°C or 27°F

6.1.12 NO THERMOSTAT HEATING INDICATOR

Indicator faulty

Check the voltage across the indicator terminals. If the voltage is correct then the indicator is faulty—replace.

If there is no voltage then check wiring.

6.1.13 ROAST TIMER (180 MINUTE) WILL NOT TIME DOWN

No power to timer

Check the voltage at terminal 5 on underside of the 180 minute timer.

Check that one lead of timer motor is connected to terminal five of timer and the other lead is connected to neutral of 'Roast 'n Hold' switch.

If voltage at terminal 5 is correct and wiring is correct then the timer motor is faulty—replace timer.

If there is no power at terminal 5, check for power supply at terminal 4 of timer. If there is voltage at terminal 4 and not at terminal 6 with timer set, then timer switch is faulty—replace timer.

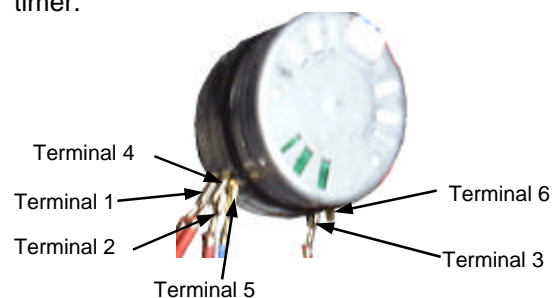

Figure 6.1.5

If terminal 4 voltage is correct, check relay at the base of the control housing behind control panel is latched ON. If relay is ON then check wiring.

If relay is not latched ON when 'Roast 'n Hold' switch illuminated then check the voltage across terminals 7 and 8 of relay coil (fig 6.1.3). If the voltage is correct but the relay is in the off position then the relay is faulty—replace.

If there is no voltage across 7 and 8 then check wiring.

'Roast 'n Hold' switch faulty

Check if the switch latches. If the switch does not latch then the switch is faulty—replace.

With the switch latched, check voltage across terminal 1 to terminal 3 or 4. If there is no voltage then check for fault in wiring.

Check voltage across terminal 2 to terminal 3 or 4. If there is no voltage then switch is faulty—replace.

NOTE: When the switch is latched, it should illuminate if operating correctly.

6.1.14 NO HOLD INDICATOR

Indicator faulty

Check the voltage across the indicator terminals. If the voltage is correct then the indicator is faulty—replace.

If there is no voltage then check wiring.

Timer faulty

NOTE: Timer in 'HOLD' position (vertical) and 'Roast n Hold' switch on (illuminated).

Check the voltage at terminal three of timer, with timer in hold position. If the voltage is correct then check wiring.

If there is no voltage then check voltage at terminal one of timer. If there is voltage at terminal one, but no voltage at terminal three with timer in hold position then timer switch is faulty—replace.

6.1.15 HOLDING TEMPERATURE INCORRECT

Hold thermostat faulty

With the power switch on and illuminated, 'Roast 'n Hold' switch on and illuminated, and the roast (180 minute) timer set to hold, check that the hold indicator is illuminated.

With a cold oven (ie room temperature) check that the oven element is heating. Test the

6.2 ACCESS

6.2.1 CONTROL PANEL

- 1) Undo the two screws on top of control panel.



Figure 6.2.1

- 2) Panel is now free to hinge at bottom. When closing the panel ensure wires and capillary tube are clear of metal or other terminals.

6.2.2 SERVICE (SIDE) PANEL

- 1) Undo the two screws holding the panel.

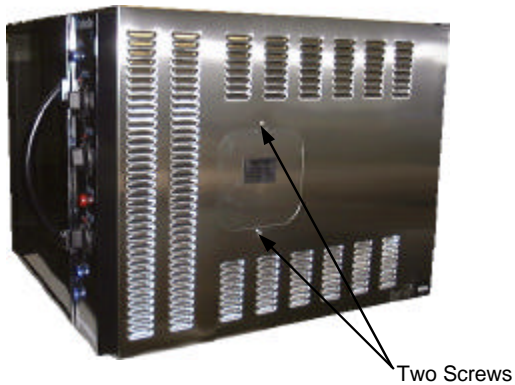

Figure 6.2.2

- 2) Remove panel.

6.2.3 SERVICE (REAR) PANELS

- 1) Undo the six screws holding the panels.
- 2) Remove panels.

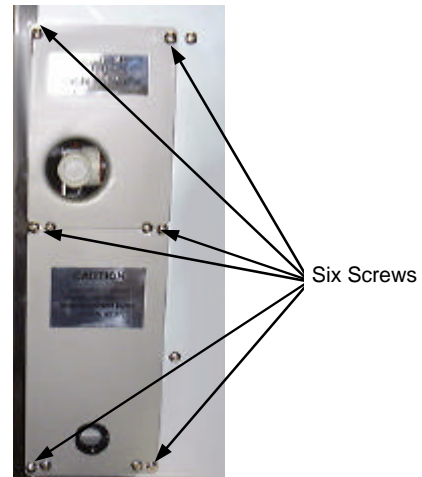

Figure 6.2.3

6.2.4 CONTROL PANEL—REAR

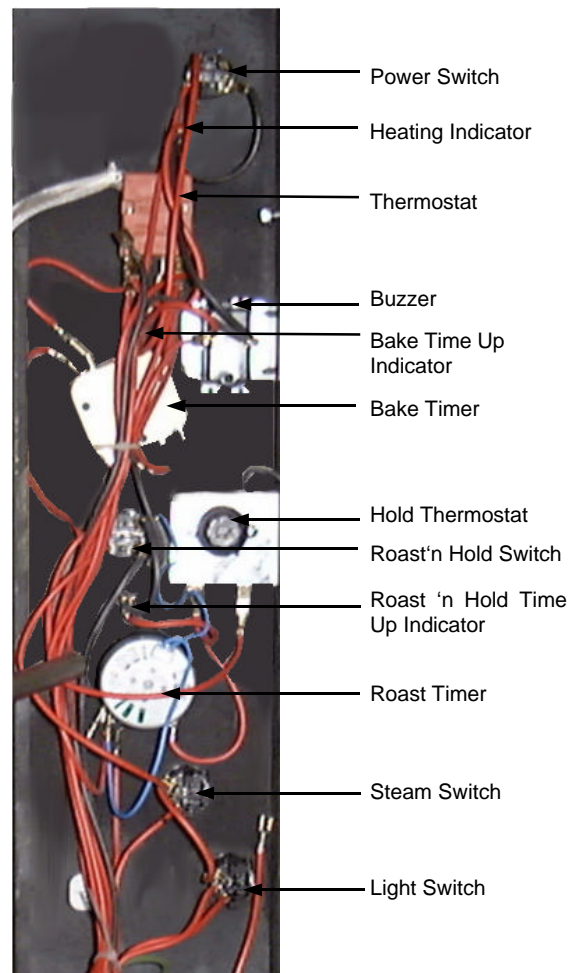

Figure 6.2.4

6.3 REPLACEMENT

6.3.1 LIGHT BULB / GLASS

- 1) Unscrew lamp cover(s).

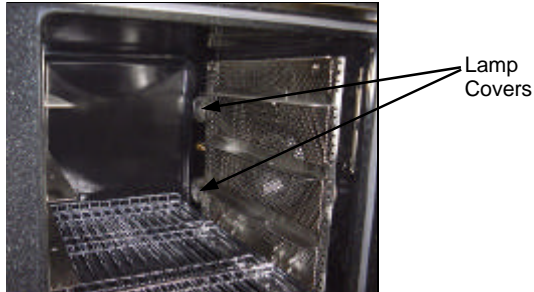

Figure 6.3.1

- 2) Unscrew bulb out of fitting.
- 3) Screw in replacement bulb.
- 4) Ensure seal fitted. Screw lamp cover into holder with baffle fitted (do not over tighten).

6.3.2 DOOR MICROSWITCH

- 1) Hinge down control panel (refer 6.2.1)
- 2) Remove two screws holding microswitch to bracket.

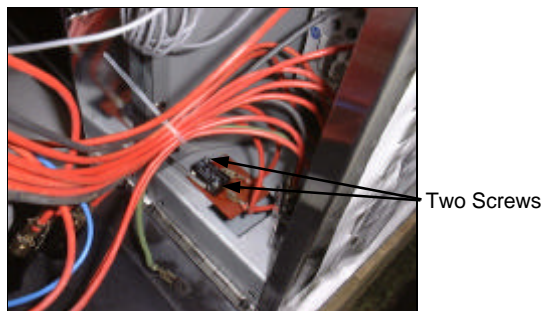

Figure 6.3.2

- 3) Transfer wires to new switch and re-assemble.
- 4) Adjust micro-switch (refer 6.4.2).

6.3.3 INDICATOR NEON LIGHT

- 1) With control panel open (refer 6.2.1) remove the wires from the back of the neon.

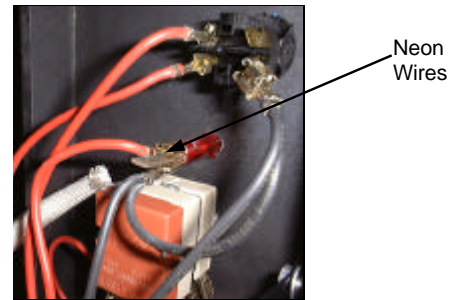

Figure 6.3.3

- 2) From back push neon through front of panel rotating clockwise.
- 3) Push new neon in from front of panel, and reconnect wires.

6.3.4 POWER / ROAST / LIGHTS / STEAM SWITCHES

- 1) With control panel open (refer 6.2.1) remove the wires from the back of the switch, noting their positions.

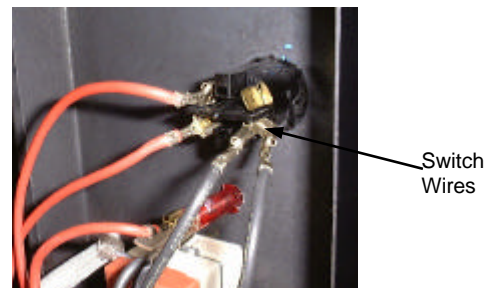

Figure 6.3.4

- 2) From back push switch through front of panel.
- 3) Push new switch in from front of panel, and reconnect wires.

6.3.5 BUZZER

- 1) Remove control panel (refer 6.2.1).
- 2) Remove two screws holding buzzer bracket to panel.

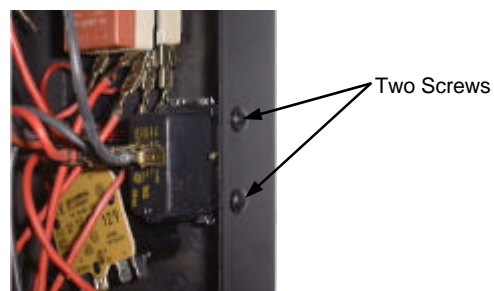

Figure 6.3.5

- 3) Withdraw and remove two screws holding buzzer to bracket.

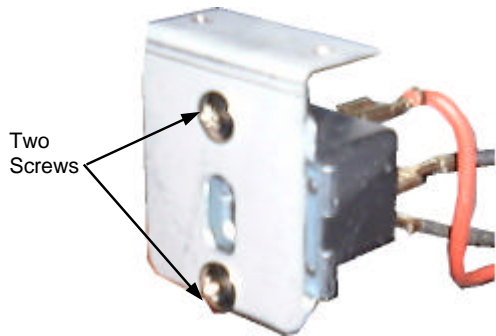

Figure 6.3.6

- 4) Transfer wires to new buzzer.
- 5) Reassemble in reverse order.

6.3.6 HOLD RELAY

- 1) Open control panel (refer 6.2.1).
- 2) Remove two screws securing relay to control panel.



Figure 6.3.7

- 3) Withdraw and transfer wires to new relay.
- 4) Reassemble in reverse order.

6.3.7 BAKE TIMER

- 1) Remove bake timer knob by pulling it firmly away from control panel.
- 2) Open control panel (refer 6.2.1) and undo two screws securing timer.

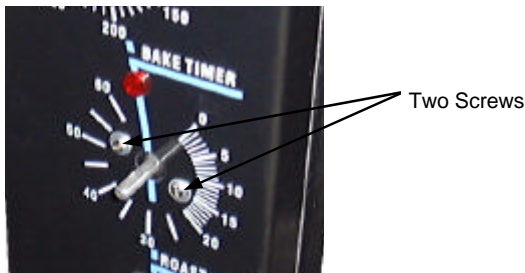

Figure 6.3.8

- 3) Transfer wires to new timer.
- 4) Withdraw old timer and insert new timer, securing with screws.
- 5) Replace knob.

6.3.8 ROAST TIMER

- 1) Remove roast timer knob by pulling it firmly away from control panel.
- 2) Open control panel (refer 6.2.1) and undo two screws securing timer.

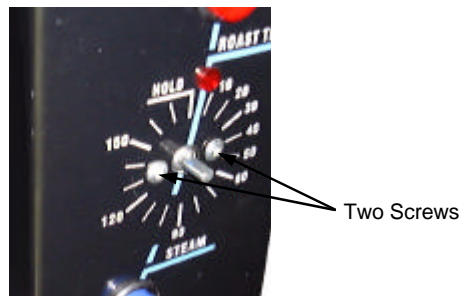

Figure 6.3.9

- 3) Transfer wires to new timer.
- 4) Withdraw old timer and insert new timer, securing with screws.
- 5) Replace knob.

6.3.9 THERMOSTAT

- 1) Pull knob off front of thermostat
- 2) Open control panel (refer 6.2.1) and undo two screws securing thermostat.

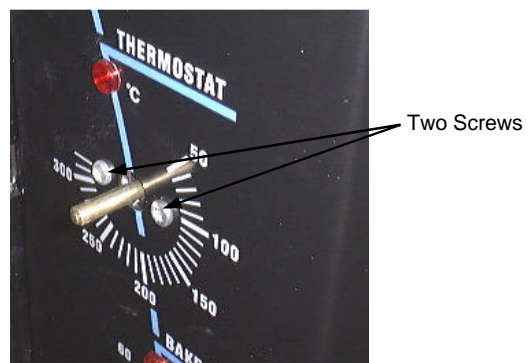

Figure 6.3.10

- 3) Transfer wires to new thermostat.
- 4) Open oven door, remove racks and fan baffle rack. Loosen two screws securing thermostat phial bracket.

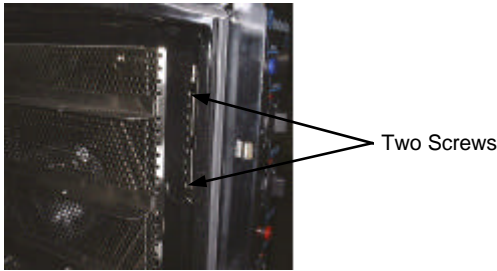

Figure 6.3.11

- 5) Withdraw old thermostat phial through side of oven. Note position in phial bracket.
- 6) Remove fibreglass sleeving from old thermostat and fit to replacement thermostat.

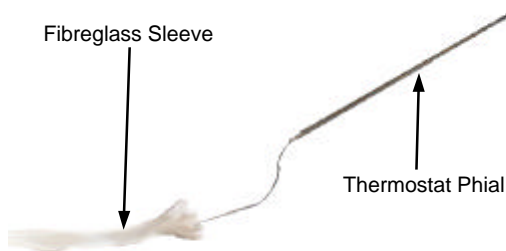

Figure 6.3.12

- 7) Insert new thermostat.
- 8) Re-assemble in reverse order.

NOTE: Ensure that the thermostat phials are located in their correct positions. The main thermostat probe must be on the side closest to the door. The hold thermostat must be on the side closest to the fan and elements.

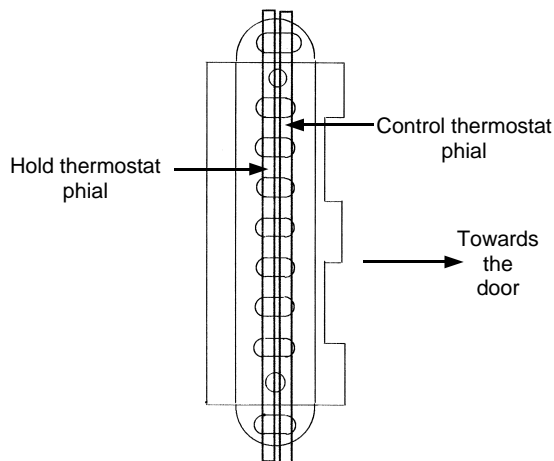

Figure 6.3.13

6.3.10 HOLD THERMOSTAT

- 1) Open control panel (refer 6.2.1) and undo two screws securing hold thermostat bracket.

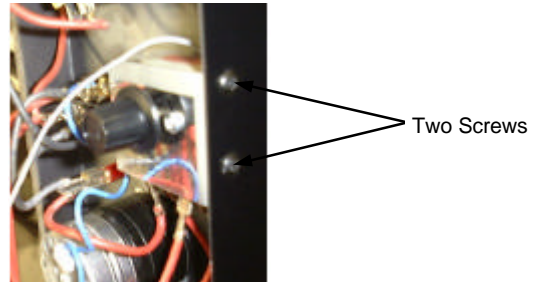

Figure 6.3.14

- 2) Transfer wires to new thermostat.
- 3) Open oven door, remove racks and fan baffle rack. Loosen thermostat phial bracket

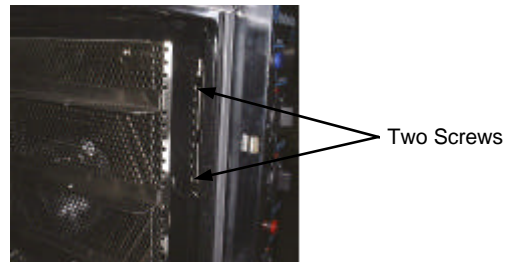

Figure 6.3.15

- 4) Withdraw old thermostat phial through side of oven. Note position in phial bracket
- 5) Insert new thermostat.
- 6) Re-assemble in reverse order.

NOTE: Ensure that the thermostat phials are located in their correct positions. The main thermostat probe must be on the side closest to the door. The hold thermostat must be on the side closest to the fan and elements (refer figure 6.3.13).

6.3.11 HEATING CONTACTOR

NOTE: For models using earlier relays and contactors (not shown) refer to appendix.

- 1) Open control panel (refer 6.2.1) and undo two screws securing heating contactor bracket to oven.

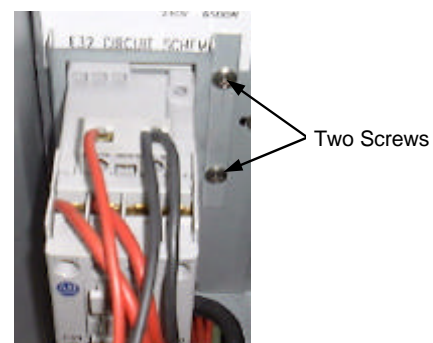

Figure 6.3.16

- 2) Unclip contactor from bracket.

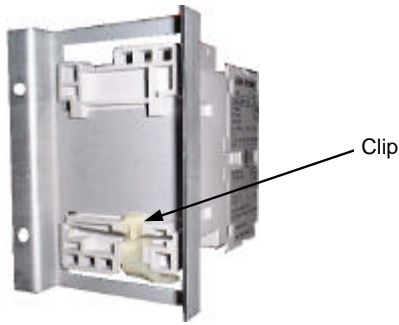

Figure 6.3.17

- 3) Clip new contactor onto bracket.
- 4) Secure new heating contactor and bracket to oven with two screws.
- 5) Transfer wires from old contactor to new contactor, ensuring all wires are in their correct positions.

6.3.12 WATER SOLENOID

- 1) Ensure water supply is turned off.
- 2) To access the solenoid, remove the rear access panel (refer 6.2.3)
- 3) To remove or replace solenoid, disconnect water solenoid from oven water tube behind water solenoid with a 1/2" (13mm) spanner.
- 4) Remove water solenoid from oven by removing two screws securing the water solenoid bracket to electrical supply junction box.

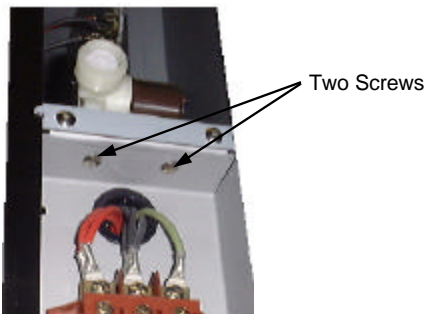

Figure 6.3.18

- 5) Carefully withdraw solenoid (including wires and bracket).
- 5) Replace or service solenoid as required.
- 6) To reinstall, reverse procedure.
- 7) Check water connections do not leak.
- 8) Check for correct water injection operation.

6.3.13 WATER SOLENOID CLEANING

- 1) Disconnect water supply from the water solenoid.
- 2) Remove the sieve from the valve assembly by pulling firmly away from the assembly with a pair of pliers.

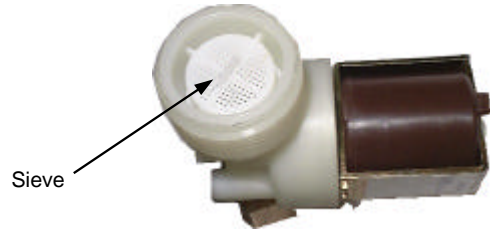

Figure 6.3.19

- 4) Clean the sieve, removing all dirt and grime.
- 5) Replace the sieve and reconnect the water supply.

6.3.14 SPRAY NOZZLE

- 1) Inside the oven remove the RH side fan baffle, then unscrew the spray nozzle.

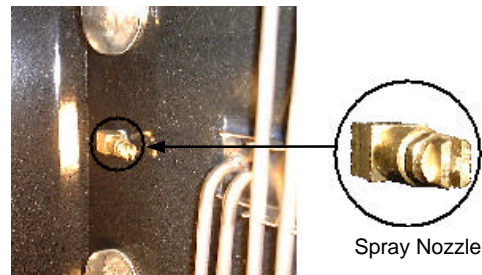

Figure 6.3.20

- 2) Clean or replace as required, ensuring debris free on re-assembly.
- 3) Ensure that the spray nozzle is installed in the vertical position.

6.3.15 ELEMENTS

- 1) Remove service panel (refer 6.2.2) and baffle.
- 2) Remove the wires from the elements.

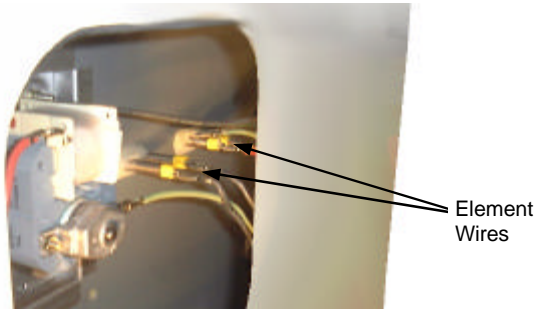

Figure 6.3.21

- 2) Unscrew the elements from inside the oven.

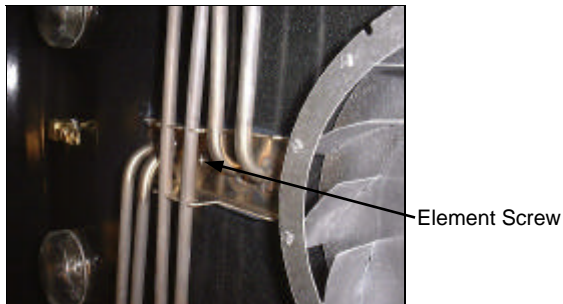

Figure 6.3.22

- 3) Pull elements carefully to remove. Silicone sealant may require effort to remove elements.
- 4) Replace and re-assemble in reverse order. Use high temperature (232°C / 450°F minimum) RTV silicone sealant to seal element against side wall of oven.

Element Rating:

208-220 V	Inner Element	17.0 ohms
	Outer Element	14.1 ohms
230-240 V	Inner Element	19.4 ohms
	Outer Element	17.0 ohms

6.3.16 FAN

- 1) With baffle removed undo the centre nut.
NOTE: LH thread - Turn clockwise to loosen.

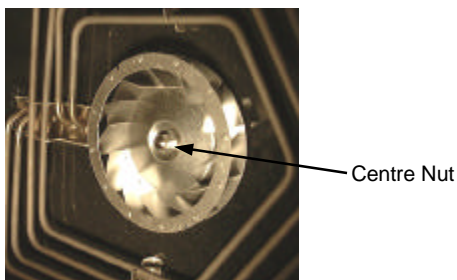

Figure 6.3.23

- 2) Replace and re-assemble in reverse order.

6.3.17 MOTOR

- 1) Remove fan (refer 6.2.16) and then remove the wires that go to the motor.
- 2) Undo the three screws holding the motor in place (from the outside) and remove motor.

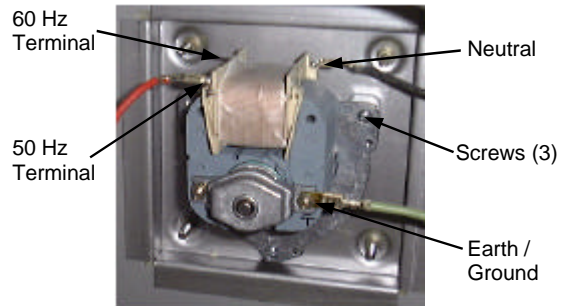

Figure 6.3.24

- 3) Replace and re-assemble in reverse order.
- 4) Ensure wire connections are correct to the voltage supply—60 Hz / 50 Hz (fig 6.3.24)

6.3.18 OUTER GLASS

- 1) Open door
- 2) Loosen the two screws securing the top pivot whilst supporting the door. The pivot can now be lifted, and the door removed from the oven.

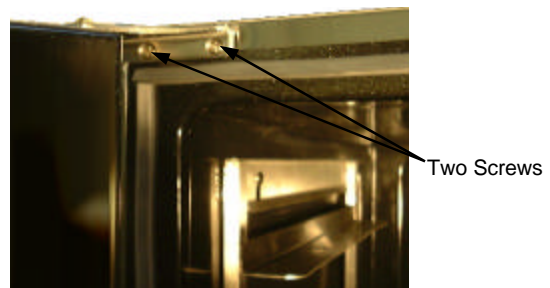

Figure 6.3.25

- 3) Remove screws securing door handle, and remove handle from the door assembly.



Figure 6.3.26

- 4) Remove two screws in top trim and two screws in bottom trim of door, and remove trim panels.

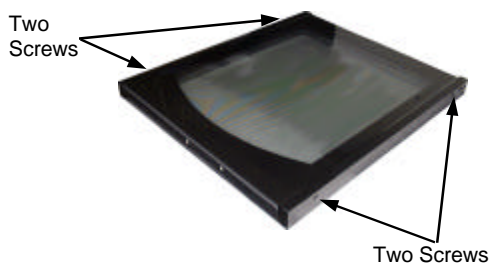

Figure 6.3.27

- 5) Lift outer glass away from door.
- 6) To replace, ensure that the two silicone rubber seals are in place on the left hand and right hand side of the door frame. Clean the inside of the glass and refit it, ensuring that the silicone rubber seals cover the outer edges of the glass. Refit the trim panels.

6.3.19 INNER GLASS

- 1) Remove the outer glass (refer 6.3.18). Uncrimp the retaining lugs of the window spacer and remove the spacer and glass.

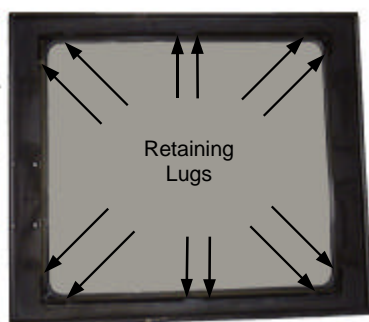

Figure 6.3.28

- 2) To replace, ensure the silicone rubber seal has not been displaced. Clean the glass and refit it. Place the window spacer in position and crimp the retaining lugs over to hold the glass in place. Refit outer glass as above.

6.3.20 DOOR SEALS

- 1) Open oven door.
- 2) To remove, hold at their centre point and pull forward until they unclip

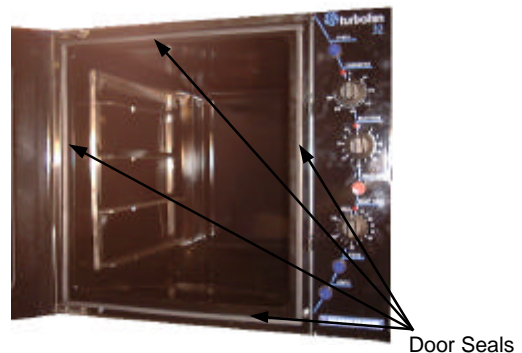

Figure 6.3.29

- 3) Refit new seals.

Note: Fit top and bottom seals first, with open side of seal facing downwards. Fit side seals with open side facing outwards.

6.3.21 DOOR PIVOT BUSHES

- 1) Remove door as per steps one and two of section 6.3.18.
- 2) Remove the top and bottom pivot brackets (two screws).

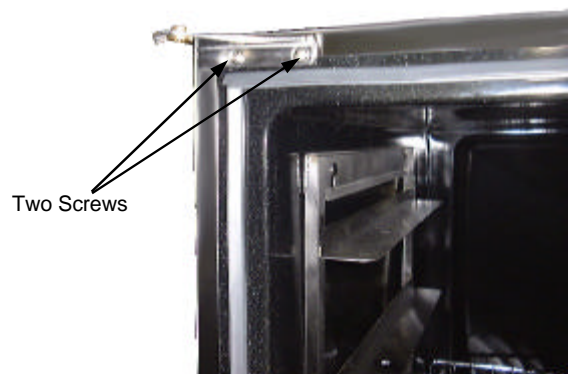

Figure 6.3.30

- 3) Door bushes can now be removed and replaced.



Figure 6.3.31

- 4) Reinstall door by reversing steps one to two of section 6.3.18.

6.3.22 STAINLESS STEEL DOOR - OUTER GLASS

- 1) Remove the door and door handle as per steps one, two and three of section 6.3.18.
- 2) Remove the pivot (two screws), and the two securing screws from the top and bottom of the door.



Figure 6.3.32

- 3) Remove the four window screws. The stainless steel door outer can now be removed.

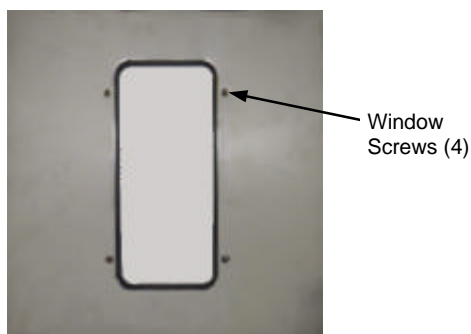

Figure 6.3.33

- 4) To replace the outer glass, simply remove and replace, taking care that the outer seals are positioned correctly around the glass edge. Reassemble in reverse order.

6.3.23 STAINLESS STEEL DOOR - INNER GLASS

- 1) Remove the outer glass (refer 6.3.22).
- 2) Uncrimp the retaining angles and remove inner glass.

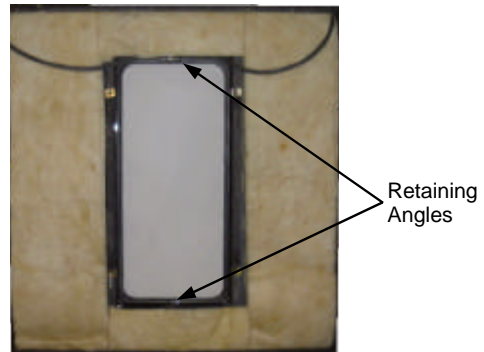

Figure 6.3.34

- 3) Replace with new glass and re-assemble door.
- 4) Refit door to the oven.

6.4 ADJUSTMENT / CALIBRATION

6.4.1 THERMOSTAT CALIBRATION

! **IMPORTANT:** IF THE OVEN TEMPERATURE NEEDS TO BE INCREASED, ENSURE THAT THE THERMOSTAT IS IN THE 'OFF' POSITION BEFORE CARRYING OUT ADJUSTMENT. IF OVEN TEMPERATURE NEEDS TO BE DECREASED, ENSURE THERMOSTAT IS IN THE 'MAX' TEMPERATURE POSITION BEFORE CARRYING OUT ANY ADJUSTMENT.

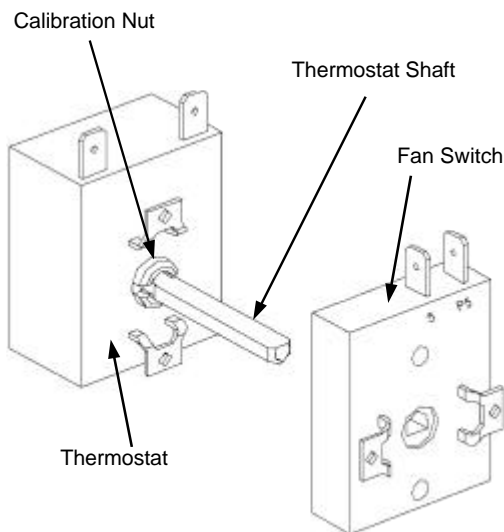

Figure 6.4.1

- 1) Turn off power.
- 2) Remove thermostat knob by pulling it firmly away from control panel.
- 3) Open control panel (refer 6.2.1). Remove two screws on control panel holding thermostat.

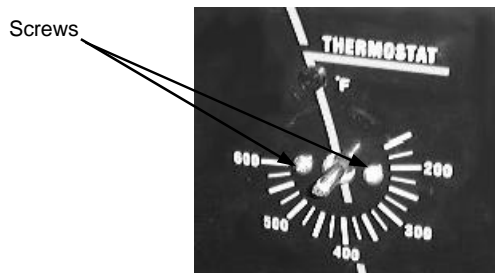

Figure 6.4.2

- 4) The thermostat can now be removed.

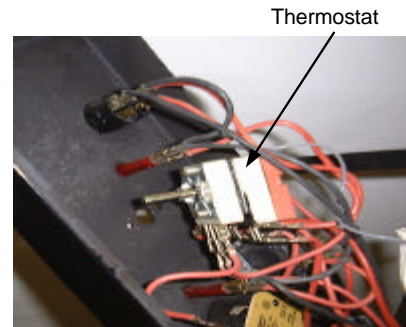

Figure 6.4.3

- 5) Carefully remove two screws holding fan switch to thermostat.

HINT: Tape fan switch assembly together before removal to prevent it from springing apart.

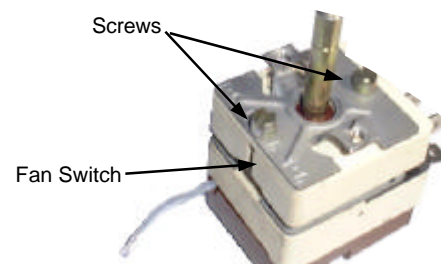

Figure 6.4.4

- 7) Adjust the calibration nut located at the base of the thermostat shaft.
To increase oven temperature, turn calibration nut anticlockwise.
To decrease oven temperature, turn calibration nut clockwise.
Adjustment of the calibration nut by 1° angular will alter oven temperature by approximately 2°C (3.6°F).

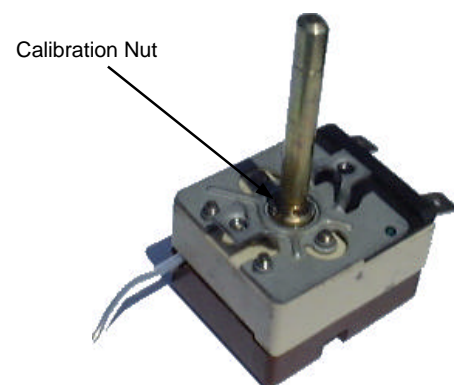

Figure 6.4.5

- 8) Reassemble fan switch onto thermostat and fit assembly back onto control panel.
- 9) Turn on power and recheck oven thermostat calibration.
- 10) Repeat procedure if necessary.

6.4.2 DOOR MICROSWITCH ADJUSTMENT

- 1) Open oven door.
- 2) Open control panel (refer 6.2.1).
- 3) With fingers, bend actuator arm of microswitch so that switch operates when door is in closed position.

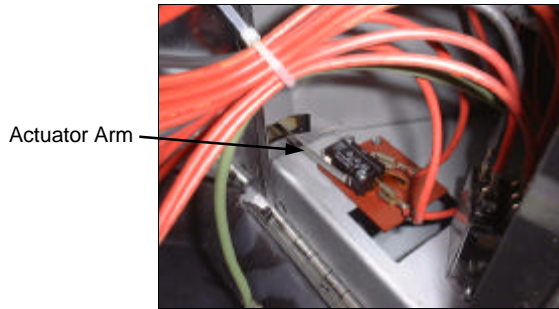

Figure 6.4.6

6.4.3 DOOR CATCH ADJUSTMENT

- 1) Open the control panel (refer 6.2.1).
- 2) Loosen the four screws securing the chrome plated bar which carries the door catches.

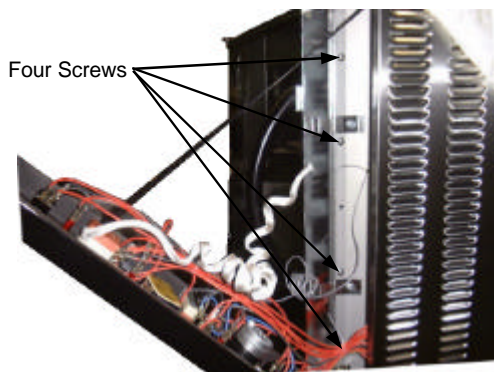

Figure 6.4.7

- 3) The door catches can now be adjusted in or out to ensure that the door seals correctly.
- 4) Tighten the screws and close the control panel.

6.4.4 DOOR ALIGNMENT

- 1) Loosen the three screws securing the bottom hinge to the oven front.

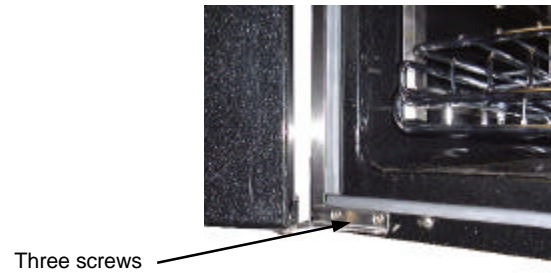

Figure 6.4.8

- 2) Adjust hinge position to align door latch with catch plate on side of door.

6.4.5 HOLD TEMPERATURE ADJUSTMENT

- 1) The hold temperature of the oven can be adjusted by turning the hold thermostat dial to the desired hold temperature. This dial is located inside the control panel.

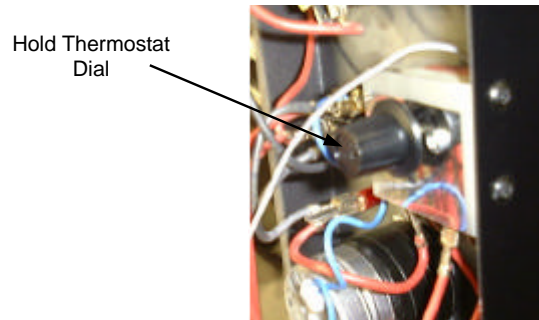

Figure 6.4.9

6.4.6 60 MINUTE TIMER ZERO POSITION ADJUSTMENT

- 1) Remove 60 minute timer knob by pulling it firmly away from control panel.
- 2) Open control panel (refer 6.2.1). Loosen two screws on control panel holding 60 minute timer.

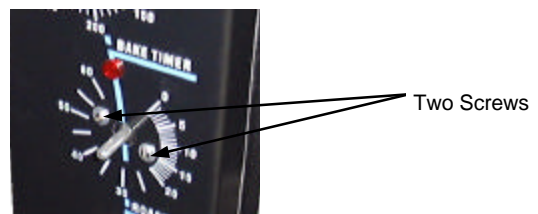
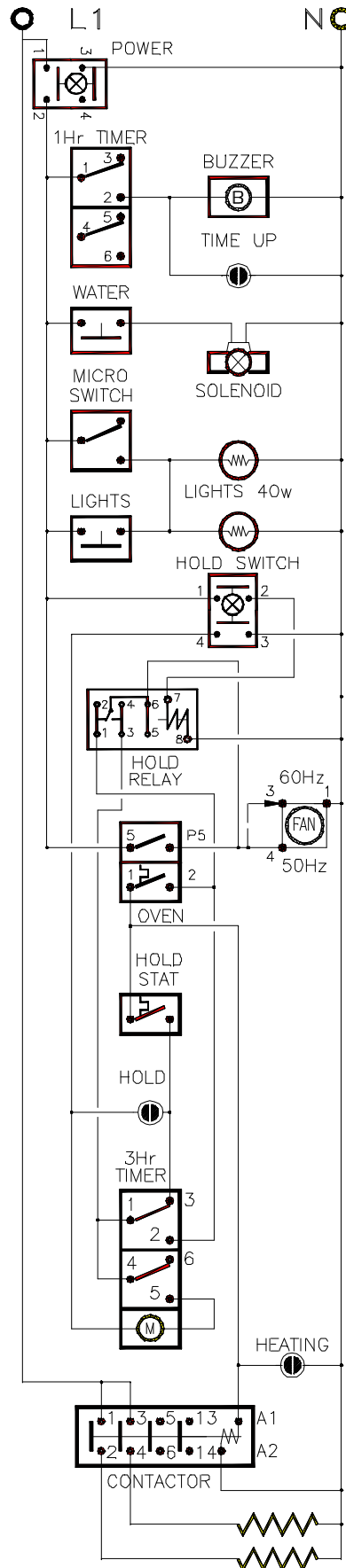

Figure 6.4.10

- 3) The timer can now be rotated as required to ensure that the buzzer sounds at the zero position.

7. ELECTRICAL CIRCUIT SCHEMATIC



8. ELECTRICAL WIRING DIAGRAM

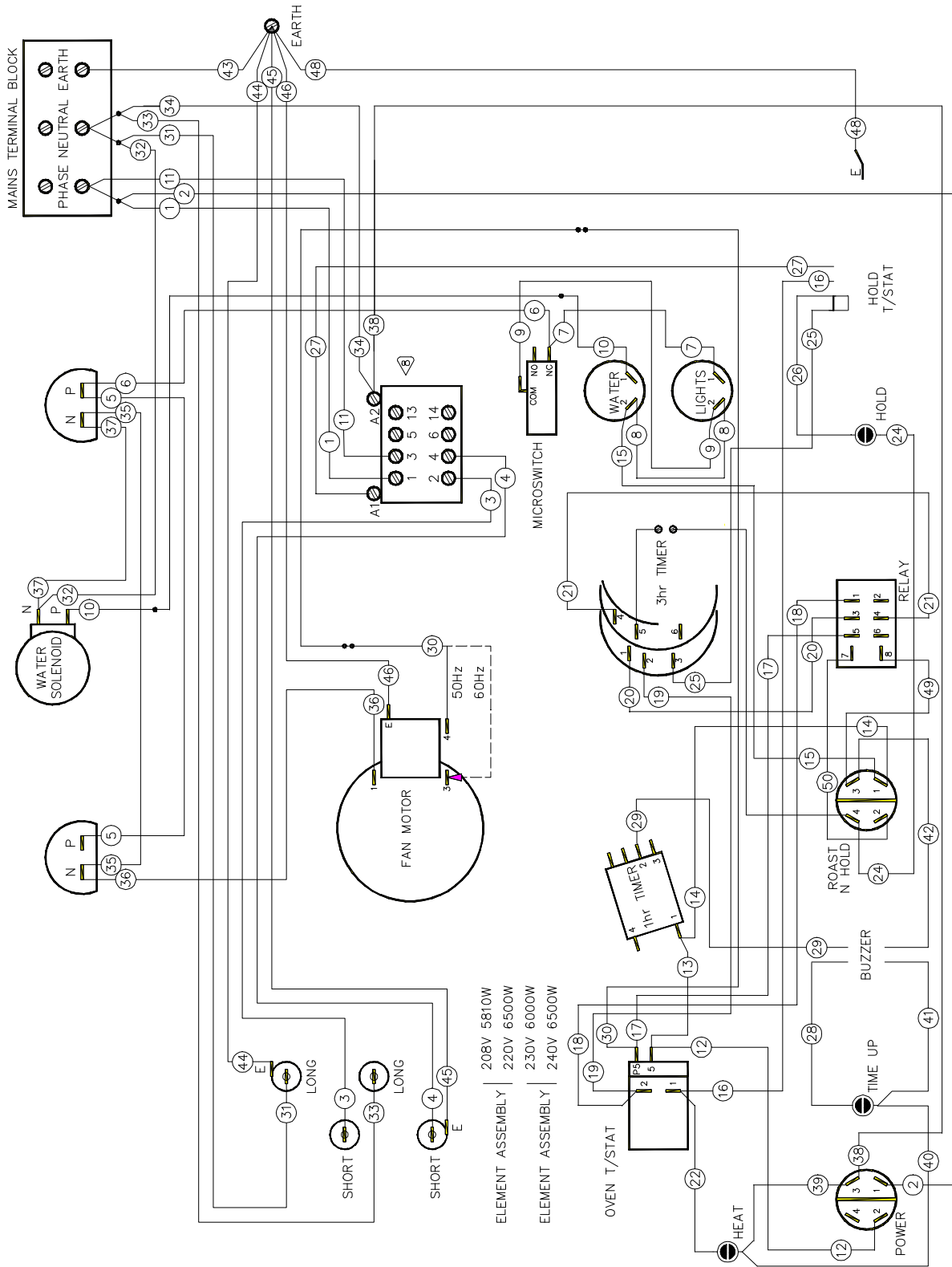

9. SPARE PARTS

PART NO	DESCRIPTION
----------------	--------------------

CONTROLS

021473	Switch - Power
011987	Thermostat
020823	Knob - Thermostat / Bake Timer
020849	Neon Indicator
011760	Bake Timer
011794	Buzzer
021476	Switch - 'Roast n Hold'
011419	'Roast n Hold' Timer
021472	'Roast n Hold' Timer Knob
021474	Switch - Steam / Light
015966	Contactora - Elements
021491	Relay - 'Roast n Hold'
018223	Hold Thermostat
003004	Microswitch
003002	Oven Lamp Glass
003434	Silk Gasket
013521	Oven Lamp - 40W Miniature Edison Screw

MOTOR & ELEMENTS

015360	Element Assembly 208-220V
015363	Element Assembly 230-240V
013431	Fan Motor
015597	Oven Fan

STEAM SYSTEM

020851	Water Solenoid
021057	Spray Nozzle Assembly
021526	Water Inlet Elbow
021527	Washer

DOOR

021520	Oven Door Seal Strip Side
021517	Oven Door Seal Strip Top / Bottom
021468	Handle
021460	Handle Bracket
021443	Door Outer Glass (Full Glass Door)
002340	Door Inner Glass (Full Glass Door)
017905	Door Bush

RACKS

015575	Oven Side Rack LH
015656	Fan Baffle
015168	Oven Rack

STACKING KIT

021543	Double Stacking Kit
--------	---------------------

10. ACCESSORIES

OVEN RACKS (PART NO 15168)

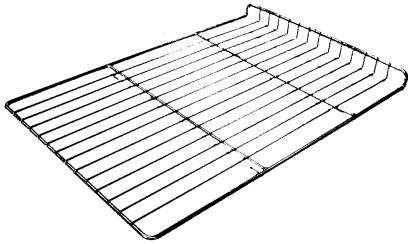

100 MM (FOUR INCH) FOOT OPTION (PART NO 13048)



25 MM (ONE INCH) FOOT OPTION (PART NO 13908)



STAINLESS STEEL DOOR OPTION



COOKIE KIT—SIX TRAY OPTION (PART NOS 17156 & 17157)

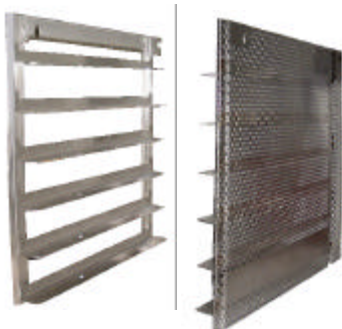

DOUBLE STACKING KIT (PART NO 021543)



A25 STAINLESS STEEL STAND



11. PARTS DIAGRAMS

11.1 MAIN ASSEMBLY

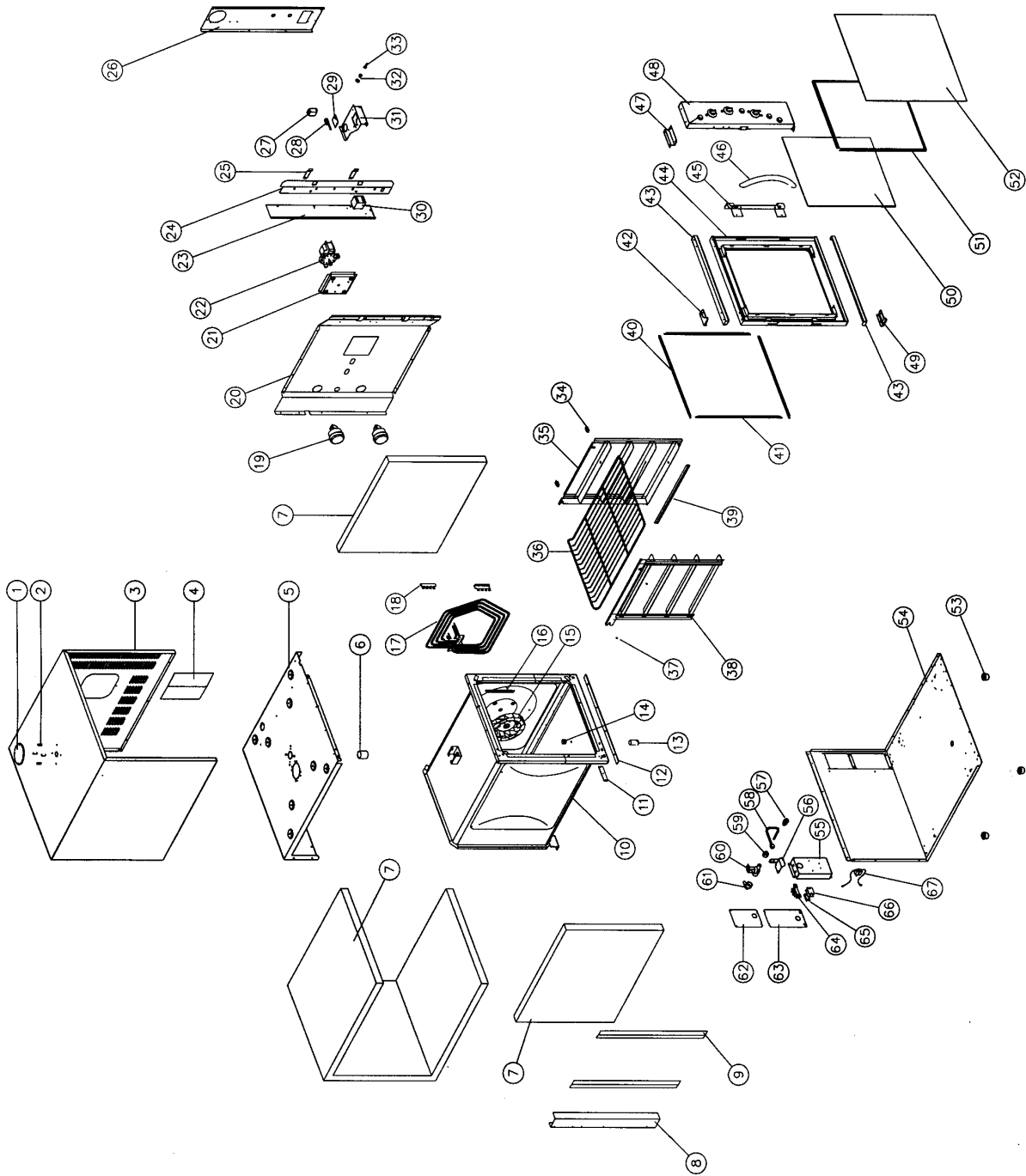

Pos	Part No.	Description
1	016241	VENT HOOD PLATE
2	016245	HOOD SPACER
3	021448	WRAPPER
4	017872	INSPECTION PANEL
5	021549	TOP INSULATION PANEL
6	014954	VENT TUBE
7	090424	FIBREGLASS - 38mm
8	013986	REAR VERTICAL
9	013978	LH INSULATION PLATE
10	004727	OVEN - ENAMELLED
11	013951	HINGE PLATE BOTTOM
12	013987	INSULATOR OVEN
13	013941	DRAIN TUBE (to 12/98)
14	002247	DRAIN PLUG (to 12/98)
15	015597	FAN
16	013974	PHIAL GUARD
17	015360	ELEMENT ASSEMBLY 220V
	015363	ELEMENT ASSEMBLY 240V
18	015581	ELEMENT BRACKET
19	013520	OVEN LIGHT ASSY
	003434	SILK GASKET
	013521	LAMP - 40W
	003002	LIGHT GLASS
20	013967	SIDE INSULATION PANEL
21	013965	MOTOR MOUNTING PLATE
22	013431	MOTOR
23	021172	HEAT BLOCK PLATE
24	021467	CATCH PLATE
25	013893	DOOR SPRING CATCH
26	021173	FRONT VERTICAL
27	021534	RELAY
28	003004	MICROSWITCH
29	013977	INSULATOR
30	020768	CONTACTOR
31	021636	MICROSWITCH BRACKET
32	013610	DOOR BUSH
33	021637	MICROSWITCH BUTTON
34	014031	OVEN BAFFLE STUD
35	015656	FAN BAFFLE
36	015168	OVEN RACK
37	041405	SCREW
38	015575	SIDE RACK LH
39	015930	BAFFLE LOCATING BRACKET
40	021517	HORIZONTAL SEAL ASSEMBLY
	021519	HORIZONTAL SEAL - 0.52M
41	021520	VERTICAL OVEN SEAL ASSEMBLY
	021522	VERTICAL SEAL - 0.55M
42	020082	TOP HINGE ASSEMBLY
	017905	BUSH
43	021532	DOOR TRIM
44	004725	DOOR INNER ENAMELLED
45	021466	DOOR HANDLE BRACKET
46	021468	HANDLE
47	021441	CONTROL PANEL MOUNTING BRACKET
48		CONTROL PANEL
49	020083	BOTTOM HINGE ASSEMBLY
	017905	BUSH

50	002340	DOOR INNER GLASS
	090200	SILICONE EXTRUSION - 1.74M (NOT ILLUSTRATED)
51	004451	GLASS CLAMP ANGLE PAINTED
52	021443	DOOR OUTER GLASS
	090225	SILICONE EXTRUSION - 1.2M (NOT ILLUSTRATED)
53	013908	FOOT ASSEMBLY 3/8"
	013048	LEG - 4" HI-TEMP PLASTIC (NOT ILLUSTRATED)
54	013966	BASE PANEL
55	015591	JUNCTION BOX
56	021618	WATER SOLENOID BRACKET
57	021057	SPRAY NOZZLE ASSEMBLY
58	021058	WATER TUBE W.A
59	020869	CONNECTOR-3/8"Fx1/4" COMPRESSION
60	020851	SOLENOID
61	021526	WATER INLET ELBOW
	021527	WASHER (NOT ILLUSTRATED)
62	021619	REAR SERVICE PANEL - TOP
63	015589	REAR SERVICE PANEL - BOTTOM
64	014185	MAINS TERMINAL BLOCK
65	002138	CABLE CLAMP
66	002441	INSULATOR
67	018959	CAPACITOR ASSEMBLY (UK ONLY)

11.2 CONTROL PANEL ASSEMBLY

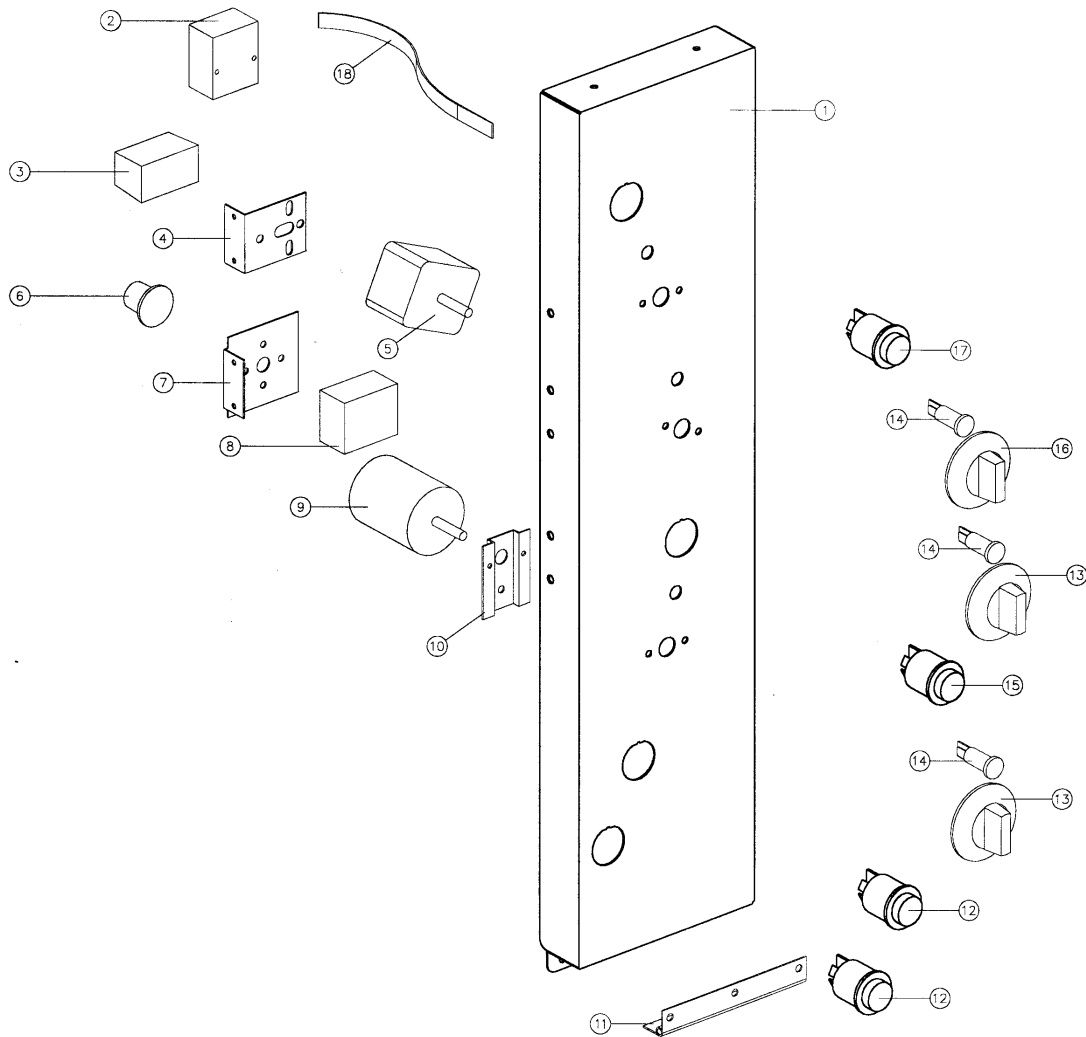

Pos	Part No.	Description
1	004723	CONTROL PANEL BAKBAR - ENAM °C
	004804	CONTROL PANEL BLUE SEAL - ENAM °C
	004730	CONTROL PANEL MOFFAT - ENAM °F
2	011987	THERMOSTAT 50 - 320°C (120-600°F)
3	011794	BUZZER
4	018224	HOLD STAT KNOB
5	021537	HOLD STAT MOUNTING BRACKET (AFFIX 018209 LABEL)
6	011760	TIMER - 1hr
7	021538	HOLD STAT BRACKET
8	018223	HOLD STAT - ADJUSTABLE
9	011419	3hr TIMER 50Hz
	011983	3hr TIMER 60Hz
10	021442	TIMER MOUNTING PANEL
11	016579	HINGE
12	021474	LIGHT/STEAM SWITCH
13	020823	TIMER KNOBS
14	020849	PILOT LIGHT
15	021476	ROAST 'N' HOLD SWITCH
16	021472	THERMOSTAT KNOB
17	021473	SWITCH - POWER
18	016602	RETAINING STRAP

11. SERVICE CONTACTS

AUSTRALIA

VICTORIA HEAD OFFICE AND MAIN WAREHOUSE

740 Springvale Road
Mulgrave VIC 3170
Spare Parts Department

Tel (03) 9518 3888
Fax (03) 9518 3838
Free Call 1800 337 963
Fax (03) 9518 3895

NEW SOUTH WALES

Unit 8/142 James Ruse Drive
Rosehill NSW 2142
Spare Parts

Free Call 1800 337 963
Fax (03) 9518 3895

QUEENSLAND

30 Prosperity Place
Geebung QLD 4034
Spare Parts

Free Call 1800 337 963
Fax (03) 9518 3895

SOUTH AUSTRALIA

Suite 8/71 Fullarton Rd
Kent Town SA 5067
Spare Parts

Tel (08) 8431 0522
Free Call 1800 337 963

WESTERN AUSTRALIA

PO Box 689
Joondalup Business Centre WA 6027
Spare Parts

Tel (08) 9305 8855
Free Call 1800 337 963

**NATIONAL COVERAGE FOR 24 HOUR SERVICE OR MAINTENANCE DIAL
FREE CALL 1800 622 216 (AUSTRALIA ONLY)**

CANADA

Lessard Agencies Limited
PO Box 97
Stn "D"
Toronto, ONT M6P 3J5

Tel (416) 766 2764
Fax (416) 760 0394
Free Call 1 888 537 7273

NEW ZEALAND

CHRISTCHURCH

16 Osborne St
PO Box 10-001
Christchurch
Spare Parts

Free Call 0800 Moffat
(0800 663 328)

Tel (03) 389 1007
Fax (03) 389 1276

AUCKLAND

4 Waipuna Road
Mt Wellington
Auckland
Spare Parts

Tel (09) 570 6630
Fax (09) 570 0099

Free Call 0800 Moffat
(0800 663 328)

UNITED KINGDOM

Units 6-7 Mount St
Business Park
Birmingham B7 5QU
England

Tel 0121-327 5575
Fax 0121-327 9711

UNITED STATES OF AMERICA

1-35 Business Center
Building 1
12000 Crown Point Drive, Suite 100
San Antonio, Texas 78233

Tel 1-800-551 8795
Fax 210-590 9479

**NATIONAL COVERAGE FOR SERVICE OR MAINTENANCE DIAL
FREE CALL 1800 551 8795 (USA ONLY)**